

# JEE MAIN 2017

## Sample Paper 5



collegedunia

## Tips For JEE Main Preparation

## PART A: CHEMISTRY

1. An aqueous solution containing 5.0 gm of horse haemoglobin in 1 litre of water shows an osmotic pressure of  $1.80 \times 10^{-3}$  atm at 298 K. What is the molecular weight of horse haemoglobin ?  
 (a) 6800                      (b) 34000                      (c) 68000                      (d) 3400
  
2. 100 ml of 0.1 M  $C_6H_5NH_2$  solution is mixed with 75 ml of 0.1 N HCl solution, what will be the pH of resulting solution (mixture) ?  
 Given that pKa is 4.74 for  $C_6H_5NH_3^+$   $\rightleftharpoons$   $C_6H_5NH_2 + H^+$   
 (a) 9.26                      (b) 9.73                      (c) 4.27                      (d) 4.74
  
3. For the following reaction,  $\frac{3}{2} O_2(g) \rightleftharpoons O_3(g)$   
 what will be the standard entropy change in the formation of ozone at 298 K ?  
 (Given  $S_{(O_3)}^0 = 56.8$  cal/mole-deg and  $S_{(O_2)}^0 = 49$  cal/mole-deg)  
 (a) +16.7 cal /mole deg                      (b) +7.8 cal/mole-deg  
 (c) – 16.7 cal/mole-deg                      (d) – 7.8 cal/mole-deg
  
4.  $K_2Cr_2O_7$  is preferred to  $Na_2Cr_2O_7$  for the use in volumetric analysis (titrations) because  
 (a)  $K_2Cr_2O_7$  is hygroscopic                      (b)  $Na_2Cr_2O_7$  is hygroscopic  
 (c) size of  $K^+$  is less than  $Na^+$  ion                      (d)  $Na_2Cr_2O_7$  is a reducing agent.
  
5. The IUPAC name of the following complex compound is  $K_2[Cr(CN)_2O_2(O_2) NH_3]$   
 (a) Potassium amminedicyanodioxoperoxochromate (VI)  
 (b) Potassium amminedioxoperoxodicyanochromate (VI)  
 (c) dipotassium amminedicyanodioxoperoxochromate (VI)  
 (d) Potassium amminedicyanobis (dioxo) chromate (V)
  
6. Regarding the energy of the 3d-electron in the sodium atom and 3d-electron in a hydrogen atom, which statement is correct ?  
 (a) In case of sodium atom it is much high than that of hydrogen atom.  
 (b) In case of sodium atom it is much less than that of hydrogen atom  
 (c) Nearly the same  
 (d) In case of hydrogen atom, electron cannot excited.
  
7. Correct order of H – C – H bond angle in following molecule.  
 $CH_4$ ,  $CH_3Cl$ , and  $CH_2Cl_2$   
 (a)  $CH_4 > CH_3Cl > CH_2Cl_2$                       (b)  $CH_2Cl_2 > CH_3Cl > CH_4$   
 (c)  $CH_3Cl = CH_4 = CH_2Cl_2$                       (d)  $CH_4 > CH_2Cl_2 > CH_3Cl$

8. At 55°C, ethanol has a vapour pressure of 168 mm, and the vapour pressure of methyl cyclohexane is 280 mm. A solution of the two, in which the mole fraction of ethanol is approximately double as that of methyl cyclohexane, has a total vapour pressure of 376 mm at 55°C. This solution formed from its components

- (a) with the evolution of heat
- (b) with the absorption of heat
- (c) may be with the evolution of heat or absorption of heat
- (d)  $\Delta H = 0$

9. Formation of delta is the result of

- (a) collision of river water (colloidal solution) with sea water (contains electrolytes)
- (b) collision of river water (contains electrolytes) with sea water (colloidal solution)
- (c) collision of river water (colloidal solution) with each other
- (d) None of these

10. An ion  $M^{n+}$  (molar mass = 30) discharged at cathode according to the following reaction

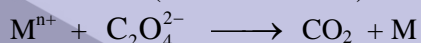

10 ml of 0.1 M solution of M is converted into  $M^{n+}$  by 20 ml of 0.03 M solution of  $KMnO_4$  in acidic medium. What weight of 'M' can be produced when 3 ampere current is passed through the solution for 9.65 hours.

- (a) 1.08 g
- (b) 10.8 g
- (c) 108 g
- (d) 32.4 g

11. For the complex ion  $[Cr(H_2O)_6]^{3+}$ , the hybridization and magnetic nature are respectively.

- (a)  $sp^3d^2$ , paramagnetic
- (b)  $d^2sp^3$ , paramagnetic
- (c)  $sp^3d^2$ , diamagnetic
- (d)  $d^2sp^3$ , diamagnetic

12. Nitramide,  $O_2NNH_2$ , decomposes slowly in aqueous solution according to the following reaction

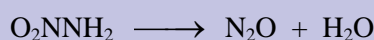

The experimental rate law is

$$\frac{d[N_2O]}{dt} = k \frac{[O_2NNH_2]}{[H^+]}$$

Which of the following step is not appropriate for the mechanism of above reaction ?

- (a)  $O_2NNH_2 \xrightleftharpoons[k_b]{k_a} O_2NNH^- + H^+$  (fast)
- (b)  $O_2NNH^- \xrightarrow{k_1} N_2O + OH^-$  (slow)
- (c)  $H^+ + O_2NNH_2 \xrightleftharpoons[k_b]{k_a} O_2NNH_3^+$  (fast)
- (d)  $H^+ + OH^- \xrightarrow{k_2} H_2O$  (fast)

13. In which case the solubility of the solute decreases as the temperature increases?
- (a)  $\text{Na}_2\text{SO}_4$  in  $\text{H}_2\text{O}$  (b)  $\text{KNO}_3$  in  $\text{H}_2\text{O}$   
 (c)  $\text{NaCl}$  in  $\text{H}_2\text{O}$  (d)  $\text{KCl}$  in  $\text{H}_2\text{O}$
14.  $\text{N}_2\text{O}_4 + \text{H}_2\text{O} \longrightarrow \text{A} + \text{B}$   
 $\text{B} \xrightarrow{\Delta} \text{C} + \text{NO} + \text{H}_2\text{O}$   
 $\text{C} + \text{H}_2\text{O} \longrightarrow \text{A} + \text{B}$   
 Identify B and C (respectively)
- (a)  $\text{HNO}_3, \text{N}_2\text{O}$  (b)  $\text{HNO}_2, \text{HNO}_3$   
 (c)  $\text{HNO}_2, \text{NO}_2$  (d)  $\text{NO}_2, \text{HNO}_3$
15. Which of following statement is incorrect ?
- (a) liquid and solid dioxygen are coloured  
 (b)  $\text{HNO}_3$  oxidizes Se to  $\text{H}_2\text{SeO}_4$   
 (c)  $\text{HNO}_3$  oxidizes S to  $\text{H}_2\text{SO}_4$   
 (d)  $\text{HNO}_3$  oxidizes Se to  $\text{H}_2\text{SeO}_3$
16. In Bessemer and Thomas processes of extraction of iron, lining of the convertor may damages due to presence of
- (a) Phosphorus (b) C (c) CO (d) Mn
17. For the reaction  $\text{H}_2(\text{g}) + \text{I}_2(\text{g}) \rightleftharpoons 2\text{HI}(\text{g})$   $K = 55.3$  at 699 K.  
 In a mixture that consists of 0.70 atm of HI and 0.02 atm each of  $\text{H}_2$  and  $\text{I}_2$  at 699 K, what will happen?
- (a) HI will be consumed (b) HI will be formed  
 (c) No change (d) HI may be consumed or formed.
18. The values of  $K_{\text{sp}}$  of following sparingly soluble salts  $\text{Ni}(\text{OH})_2$ ,  $\text{Ce}(\text{OH})_4$ ,  $\text{AgCN}$  and  $\text{Al}_2(\text{SO}_4)_3$  are respectively  $2 \times 10^{-15}$ ,  $4 \times 10^{-35}$ ,  $6 \times 10^{-17}$  and  $3.2 \times 10^{-34}$ .  
 Which salt is most soluble?
- (a)  $\text{Ni}(\text{OH})_2$  (b)  $\text{Ce}(\text{OH})_4$  (c)  $\text{Al}_2(\text{SO}_4)_3$  (d)  $\text{AgCN}$
19. A tetrahedral site in a closest packed lattice can be generated by placing four spheres of radius 'R' at alternate corners of the cube. What is the length of the body diagonal of this cube ?
- (a)  $\sqrt{6} R$  (b)  $2R$  (c)  $2\sqrt{2}R$  (d)  $3R$
20. In an adiabatic expansion of 1 mole of a gas
- (a) its temperature decreases (b) its temperature increases  
 (c) its temperature remains constant (d) can't predict.

21. In SHE, the pH of the acid solution should be  
 (a) 7 (b) 14 (c) 0 (d) 4
22. Which of the following can't behave as an electrophile in electrophilic aromatic substitution reactions?  
 (a)  $\text{SO}_3$  (b)  $\text{NO}_2^+$  (c)  $\text{Na}^+$  (d)  $\text{R}^+$
23. In which of the following conditions enol percentage of  $\text{CH}_3\text{COCH}_2\text{COCH}_3$  is minimum?  
 (a) In nonpolar solvent (b) In aqueous medium  
 (c) pure liquid state of  $\text{CH}_3\text{COCH}_2\text{COCH}_3$  (d) In benzene

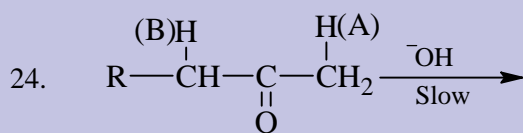

Which is correct ?

- (a) A is more reactive than B (b) B is more reactive than A  
 (c) both are of same reactivity (d) H can't release
25. What will be the major product of following reaction:  $\text{CH}_3\text{OH} \xrightarrow[\text{heat}]{\text{H}_2\text{SO}_4}$   
 (a)  $\text{CO}_2$  (b)  $\text{CH}_3-\text{O}-\text{CH}_3$   
 (c)  $\text{CH}_4$  (d)  $\overset{+}{\text{C}}\text{H}_3$
26. Which type of linkage is present in starch ?  
 (a)  $\text{C}_1-\text{C}_4$  glucosidic linkage (b)  $\text{C}_1-\text{C}_6$  glucosidic linkage  
 (c) both (a) and (b) (d) amide linkage

27. In the extraction process of aluminium from bauxite ore, aluminium hydroxide is precipitated from the strongly alkaline aluminate solution, by bubbling in some  $\text{CO}_2$ . The function of  $\text{CO}_2$   
 (a) to increase the pH (b) to decrease the pH  
 (c) to remove waste material like ironoxide (d)  $\text{CO}_2$  has no effect in above process
28. Which of the following is not aromatic ?

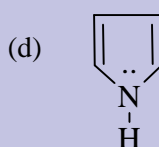
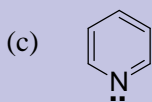
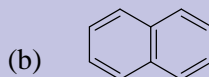
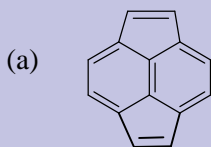

29. Correct order of boiling point of following amines  
Primary amine (I), secondary amines (II), and tertiary amine (III)
- (a) (I) > (II) > (III)                      (b) (III) > (II) > I  
(c) (II) > (III) > (I)                      (d) (II) > (I) > (III)
30. Which of the following does not contribute towards the formation of photochemical smog?
- (a) NO    (b) SO<sub>2</sub>  
(c) O<sub>3</sub>    (d) Hydrocarbons

## PART B: PHYSICS

31. The acceleration  $a$  (in  $\text{ms}^{-2}$ ) of a body, starting from rest varies with time  $t$  (in s) according to the relation  $a = 3t + 4$

The velocity of the body at time  $t = 2\text{s}$  will be

- (a)  $10 \text{ ms}^{-1}$                       (b)  $12 \text{ ms}^{-1}$                       (c)  $14 \text{ ms}^{-1}$                       (d)  $16 \text{ ms}^{-1}$
32. Light of wavelength  $4500\text{\AA}$  in air is incident on a plane boundary between air and another medium at an angle  $30^\circ$  with the plane of boundary. As it enters from air into the other medium it deviates by  $15^\circ$  towards normal. Find the wavelength of given light in the medium

- (a)  $3700\text{\AA}$                       (b)  $3800\text{\AA}$                       (c)  $3674\text{\AA}$                       (d)  $3895\text{\AA}$

33. As shown in the figure below. Friction force on  $10 \text{ kg}$  block will be

- (a)  $50 \text{ N}$     (b)  $100 \text{ N}$   
(c) zero    (d) None

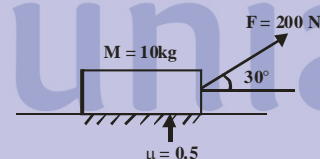

34. A car is traveling along  $x$ -axis with constant speed  $50 \text{ m/sec}$ ; a telescopic camera is rotated. Such that it can observe the car. When  $\theta = 60^\circ$  angular velocity of camera will be

- (a)  $0.25 \text{ rad/sec}$   
(b)  $0.5 \text{ rad/sec}$   
(c)  $1 \text{ rad/sec}$   
(d) None

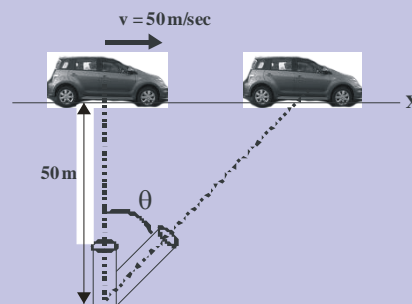

35. A particle is projected with  $40 \text{ m/sec}$  making angle  $60^\circ$  from horizontal radius of curvature when it will make angle  $30^\circ$  from horizontal

- (a)  $\frac{32}{3\sqrt{3}}$                       (b)  $\frac{32}{\sqrt{3}}$                       (c)  $\frac{32\sqrt{3}}{3}$                       (d) None

36. A magnet makes 30 oscillations per minute at a place where  $H = 0.15 \times 10^{-4} \text{ T}$ . At another place, it takes 1.5 second to complete one vibration. What is the value of earth's horizontal field at that place ?

- (a)  $0.26 \times 10^{-4} \text{ T}$                       (b)  $0.26 \times 10^{-5} \text{ T}$                       (c)  $0.26 \times 10^{-6} \text{ T}$                       (d)  $0.26 \times 10^{-7} \text{ T}$

37. An satellite of mass  $m$ , is orbiting around the earth at a distance  $r$  from centre of earth, if it stopped suddenly the loss in total energy will be
- (a)  $\frac{GMm}{2r}$       (b)  $-\frac{GMm}{r}$       (c)  $-\frac{GMm}{2r}$       (d) None

38. In figure shown there is no slipping friction on disc will be
- (a)  $\frac{F}{3}$       (b) zero  
(c)  $\frac{2F}{3}$       (d) None

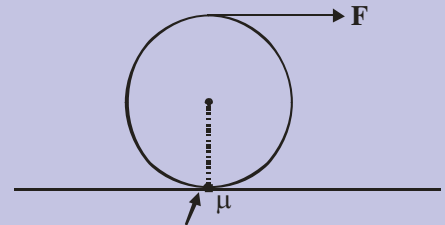

39. Two identical capacitors, have the same capacitance  $C$ . One of them is charged to potential  $V_1$  and the other to  $V_2$ . The negative ends of the capacitors are connected together. When the positive ends are also connected, the decrease in energy of the combined system is
- (a)  $\frac{1}{4} C(V_1^2 - V_2^2)$       (b)  $\frac{1}{4} C(V_1^2 + V_2^2)$       (c)  $\frac{1}{4} C(V_1 - V_2)^2$       (d)  $\frac{1}{4} C(V_1 + V_2)^2$

40. Equivalent resistance between A and B.

- (a)  $\frac{20}{9} \Omega$       (b)  $\frac{9}{2} \Omega$   
(c)  $\frac{11}{5} \Omega$       (d) None

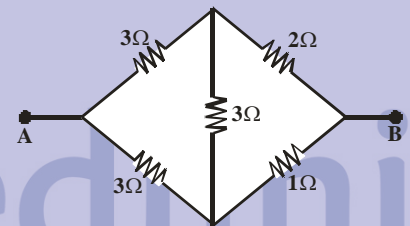

41. Potential difference between A and B

- (a) 22 Volt  
(b) - 8 Volt  
(c) Zero  
(d) None

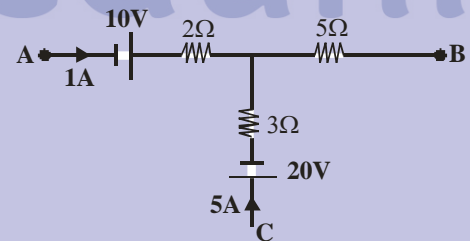

42. Time constant of circuit will be

- (a)  $5 \mu\text{sec}$   
(b)  $6 \mu\text{sec}$   
(c)  $3 \mu\text{sec}$   
(d)  $1 \mu\text{sec}$

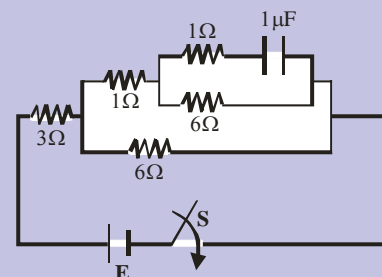

43. Work done by gas in cyclic process will be

- (a) - 50 J      (b) 100 J  
(c) 50 J      (d) - 100 J

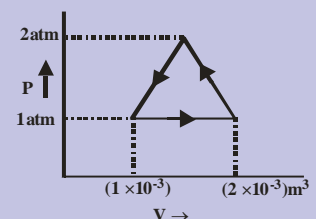

**Passage Type Question:**

A cylinder, fitted with a frictionless piston, contains one mole of an ideal gas. The walls of the cylinder and the piston are adiabatic. The cylinder contains a resistor of resistance  $R = 2.0 \text{ k}\Omega$ , which is connected to a capacitor of capacity  $C = 2.5 \text{ mF}$ . Initially, potential difference across the capacitor is  $4\text{V}$  and the switch is open. The switch is closed at time  $t = 0$  for  $(2.5 \ln 4)$  seconds, the gas expands isobarically and its temperature changes by  $72 \text{ K}$ . The heat loss through the wire is negligible.

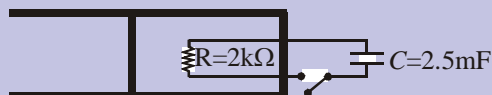

44. The increment in internal energy of the gas is  
 (a) 0.25 KJ                      (b) 0.20 KJ                      (c) 0.15 KJ                      (d) 0.10 KJ
45. The value of  $\gamma$  is [Given  $R = 8.3 \text{ Jmol}^{-1} \text{ K}^{-1}$ ]  
 (a) 1.16                      (b) 1.20                      (c) 1.4                      (d) None of these

46. Potential difference between 'a' and 'b' will be when S is closed;  
 (a) 100 volt  
 (b) zero  
 (c) 50 volt  
 (d) none

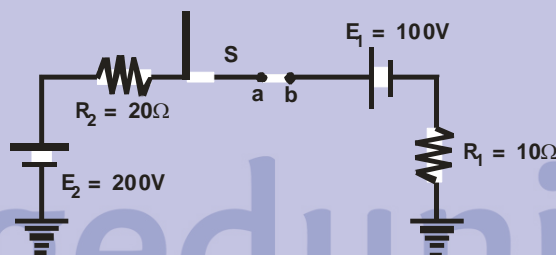

47. The work function of a substance is  $4.0 \text{ eV}$ . The longest wavelength of light that can cause photoelectron emission from this substance is approximately  
 (a) 540 nm                      (b) 400 nm  
 (c) 310 nm                      (d) 220 nm

48. The circuit shown in the figure contains two diodes each with a forward resistance  $50 \Omega$  and with infinite backward resistance, if the battery voltage is  $6\text{V}$ , the current through the  $100 \Omega$  resistance (in appear) is  
 (a) zero                      (b) 0.02  
 (c) 0.03                      (d) 0.04

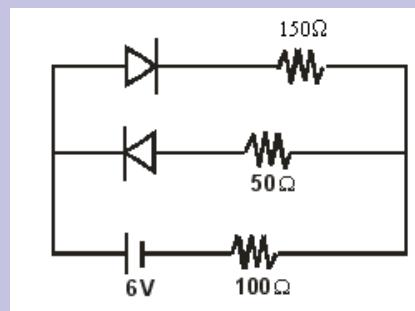

49. If radius of earth were to shrink by one percent, its mass remaining same, the acceleration due to gravity on the earth's surface would  
 (a) Decrease                      (b) Remain unchanged  
 (c) Increase                      (d) Be zero



50. Spring man system is placed on smooth horizontal surface. Initially system is equilibrium man  $m_2$  is given  $v_1 = 10$  m/sec and  $m_1$  is given 5 m/sec velocity of centre of man will be

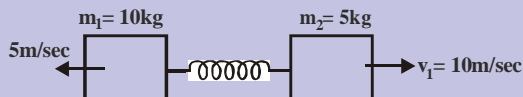

- (a)  $\frac{10}{3}$  m/sec      (b) 5 m/sec      (c) zero      (d) None

51. As shown below current  $I_2$  will be

- (a) 5A  
(b) 3A  
(c) 4A  
(d) None

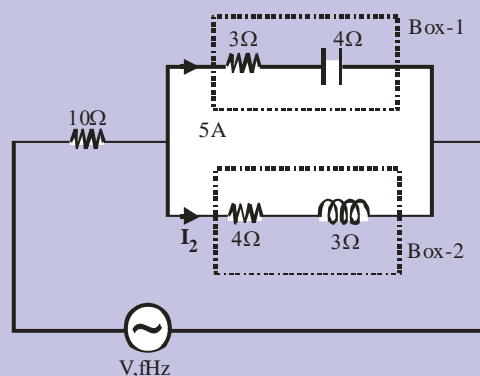

52. A symmetrical square lamina of mass  $M$  has uniform semi-circular plates attached to it on its four sides as shown in the figure. Each plate has the same mass  $M$ , and the side of a square is equal to  $a$ . The moment of inertia of the system about an axis passing through the centre  $O$ , perpendicular to the plane of the lamina is

- (a)  $\frac{13}{6}Ma^2$       (b)  $\frac{25}{12}Ma^2$   
(c)  $\frac{25}{6}Ma^2$       (d) none of these

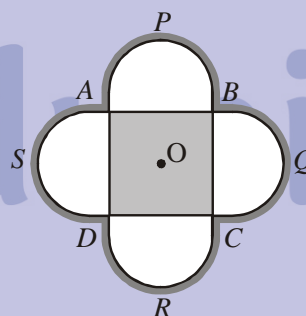

53. A metal ball immersed in alcohol weighs  $W_1$  at  $0^\circ\text{C}$  and  $W_2$  at  $70^\circ\text{C}$ . The coefficient of cubical expansion of the metal is less than that of alcohol. Assuming that the density of the metal is large compared to that of alcohol, it can be shown that

- (a)  $W_1 > W_2$       (b)  $W_1 = W_2$       (c)  $W_1 < W_2$       (d)  $W_1 = (W_2 / 2)$

54. A hydrogen atom in ground state absorbs 10.2 eV of energy. The orbital angular momentum of electrons is increased by

- (a)  $1.05 \times 10^{-34}$  J-S      (b)  $4.22 \times 10^{-34}$  J-S  
(c)  $3.16 \times 10^{-34}$  J-S      (d)  $2.11 \times 10^{-34}$  J-S

55. A convex lens of focal length 'f' is placed between an object and screen. Distance between object and screen is 15 cm. If magnification produced by lens is 3, then the focal length 'f' is

- (a)  $\frac{45}{16}$  cm      (b)  $\frac{45}{4}$  cm      (c) 80 cm      (d) 20 cm

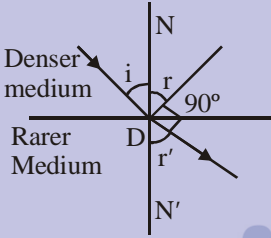
56. An electron in a hydrogen atom makes a transition from  $n_1$  to  $n_2$ . The time period of the electron in the initial state is eight times that in the final state. The possible value of  $n_1$  and  $n_2$  are
- (a)  $n_1 = 6, n_2 = 4$  (b)  $n_1 = 8, n_2 = 2$   
(c)  $n_1 = 8, n_2 = 1$  (d)  $n_1 = 6, n_2 = 3$
57. An ideal gas (whose  $\frac{C_p}{C_v} = \gamma$ , and internal energy  $U$  at absolute zero temp. is equal to zero) undergoes a reversible adiabatic compression. If  $U, p, V, T$  represent the internal energy, pressure, volume and temperature respectively of the ideal gas, then
- (a)  $UV^\gamma = \text{const.}$  (b)  $Up^\gamma = \text{const.}$   
(c)  $VU^{\frac{1}{\gamma-1}} = \text{const.}$  (d)  $TU^{\gamma-1} = \text{const.}$
58. A ray of light is incident from a denser medium on the surface of separation of a rarer medium. The reflected and refracted rays are inclined to each other at  $90^\circ$ . The angles of reflection and refraction are  $r$  and  $r'$  respectively. The critical angle is
- (a)  $\sin^{-1}(\tan r)$  (b)  $\tan^{-1}(\sin r)$   
(c)  $\sin^{-1}(\tan r')$  (d)  $\tan^{-1}(\sin r')$
- 
59. The wavelength of characteristic X-ray  $K_\alpha$  line emitted by hydrogen like atom is  $0.32 \text{ \AA}$ . The wavelength of  $K_\beta$  line emitted by the same element is
- (a)  $0.18 \text{ \AA}$  (b)  $0.48 \text{ \AA}$  (c)  $0.27 \text{ \AA}$  (d)  $0.38 \text{ \AA}$
60. When two moles of monoatomic gas expands the ratio of the heat supplied that increases the internal energy of the gas and that used in the expansion is
- (a)  $\infty$  (b)  $0$  (c)  $3/2$  (d)  $2/3$

## PART C: MATHEMATICS

61. If the function  $f, g, h$  are defined from the sets of real numbers  $R$  to  $R$  such that  $f(x) = x^2 - 1$ ,  $g(x) = \sqrt{x^2 + 1}$ ,  $h(x) = \begin{cases} 0 & \text{if } x \leq 0 \\ x & \text{if } x \geq 0 \end{cases}$ , then the composite function  $h \circ f \circ g(x) = ?$
- (a)  $\begin{cases} 0, & x = 0 \\ x^2, & x > 0 \\ -x^2, & x < 0 \end{cases}$  (b)  $\begin{cases} 0, & x = 0 \\ x^2, & x \neq 0 \end{cases}$  (c)  $\begin{cases} 0, & x \leq 0 \\ x^2, & x \geq 0 \end{cases}$  (d) None of these
62. If  $|z| = \text{Max. } \{|z - 2|, |z + 2|\}$ , then
- (a)  $|z + \bar{z}| = 1$  (b)  $z + \bar{z} = 2^2$  (c)  $|z + \bar{z}| = 2$  (d) None of these

63. Let  $R = \{(x, y) : x, y \in \mathbb{R}, x^2 + y^2 \leq 25\}$   
 $R' = \left\{ (x, y) : x, y \in \mathbb{R}, y \geq \frac{4}{9}x^2 \right\}$ , then
- (a) Domin  $(R \cap R') = \{-4, 4\}$  (b) Range  $(R \cap R') = [0, 4]$   
(c) Range  $(R \cap R') = [0, 5]$  (d)  $R \cap R'$  does not define a function
64. In a certain test, there are  $n$  questions. In this test,  $2^k$  students gave wrong answers to at least  $(n - k)$  questions, where  $k = 0, 1, 2, \dots, n$ . If the total number of wrong answer is 4095, then the value of  $n$  is
- (a) 11 (b) 12 (c) 13 (d) 15
65. A problem in mathematics is given to 3 students whose chances of solving individually are  $\frac{1}{2}, \frac{1}{3}$  and  $\frac{1}{4}$ . The probability that the problem will be solved at least by one is
- (a)  $\frac{1}{4}$  (b)  $\frac{1}{24}$  (c)  $\frac{23}{34}$  (d)  $\frac{3}{4}$
66. If  $\sin^{-1}x + \sin^{-1}y + \sin^{-1}z = \pi$ , then  $x^4 + y^4 + z^4 + 4x^2y^2z^2 = k[x^2y^2 + y^2z^2 + z^2x^2]$ , where  $k =$
- (a) 1 (b) 2 (c) 4 (d) none of these
67. The value of  $a$  for which the system of equations  
 $a^3x + (a + 1)^3y + (a + 2)^3z = 0$   
 $ax + (a + 1)y + (a + 2)z = 0$   
 $x + y + z = 0$ , has a non zero solution is
- (a) 1 (b) 0 (c) -1 (d) None of these
68. If  $A, B$  and  $C$  are three square matrices of the same size such that  $B = CAC^{-1}$ , then  $CA^3C^{-1}$  is equal to
- (a)  $B$  (b)  $B^2$  (c)  $B^3$  (d)  $B^9$
69. For all  $x \in \mathbb{R}$ , if  $mx^2 - 9mx + (5m + 1) > 0$ , then  $m$  lies in the interval.
- (a)  $\left(-\frac{4}{61}, 0\right)$  (b)  $\left[0, \frac{4}{61}\right)$  (c)  $\left(\frac{4}{61}, \frac{61}{4}\right)$  (d)  $\left[-\frac{61}{4}, 0\right]$
70. If minimum value of  $f(x) = (x^2 + 2bx + 2c^2)$  is greater than the maximum value of  $g(x) = -x^2 - 2cx + b^2$ , then  $(x \in \mathbb{R})$
- (a)  $|c| > \frac{|b|}{\sqrt{3}}$  (b)  $\frac{|c|}{\sqrt{2}} > |b|$   
(c)  $-1 < c < \sqrt{2}b$  (d) no real values of  $b$  and  $c$  exist

71.  $\int \frac{(x^2 - 1)dx}{x\sqrt{(x^2 + \alpha x + 1)(x^2 + \beta x + 1)}}$  is equal to
- (a)  $\log \left[ \frac{\sqrt{x^2 + \alpha x + 1} + \sqrt{x^2 + \beta x + 1}}{\sqrt{x}} \right] + c$       (b)  $2\log \left[ \frac{\sqrt{x^2 + \alpha x + 1} - \sqrt{x^2 + \beta x + 1}}{\sqrt{x}} \right] + c$
- (c)  $\log \left[ \sqrt{x^2 + \alpha x + 1} - \sqrt{x^2 + \beta x + 1} \right] + c$       (d) None of these
72. If  $\theta$  is the angle subtended by the circle  $S = x^2 + y^2 + 2gx + 2fy + c = 0$  at a point  $(x_1, y_1)$  outside the circle and  $S_1 = x_1^2 + y_1^2 + 2gx_1 + 2fy_1 + c$ , then  $\cos \theta = ?$
- (a)  $\frac{S_1 + c - g^2 - f^2}{S_1 - c + g^2 + f^2}$       (b)  $\frac{S_1 + c + g^2 - f^2}{S_1 - c + g^2 - f^2}$
- (c)  $\frac{S_1 - c + g^2 + f^2}{S_1 + c - g^2 + f^2}$       (d)  $\frac{S_1 - c + g^2 + f^2}{S_1 + c + g^2 - f^2}$
73. The number of irrational terms in the expansion of  $(5^{1/6} + 2^{1/8})^{100}$  is
- (a) 96      (b) 97      (c) 98      (d) 99
74. If  $a, b, c$  are in A.P.  
 $p, q, r$  are in H.P.  
 and  $ap, bq, cr$  are in G.P. then  $\left( \frac{p}{r} + \frac{r}{p} \right)$  is equal to
- (a)  $\frac{a}{c} + \frac{c}{a}$       (b)  $\frac{a}{c} - \frac{c}{a}$       (c)  $\frac{b}{q} + \frac{q}{b}$       (d)  $\frac{b}{q} - \frac{a}{p}$
75. The function  $f(x) = p[x + 1] + q[x - 1]$ , where  $[x]$  is the greatest integer function is continuous at  $x = 1$ , if
- (a)  $p - q = 0$       (b)  $p + q = 0$       (c)  $p = 0$       (d)  $q = 0$
76. If  $f'(x) = g(x)(x - a)^2$ , where  $g(1) \neq 0$  and  $g(x)$  is continuous at  $x = a$ , then
- (a)  $f$  is increasing in the nbd of  $a$  if  $g(1) > 0$  and  $f$  is decreasing in the nbd of  $a$  if  $g(1) < 0$
- (b)  $f$  is increasing in the nbd of  $a$  if  $g(1) < 0$
- (c)  $f$  is decreasing in the nbd of  $a$  if  $g(1) > 0$
- (d)  $f$  is increasing in the nbd of  $a$  if  $g(1) < 0$  and  $f$  is decreasing in the nbd of  $a$  if  $g(1) > 0$
77. Rolle's Theorem holds for the function  $f(x) = x^3 + bx^2 + cx$ ,  $1 \leq x \leq 2$  at the point  $\frac{4}{3}$ , the value of  $b$  and  $c$  are
- (a)  $b = 8, c = -5$       (b)  $b = -5, c = 8$       (c)  $b = 5, c = -8$       (d)  $b = -5, c = -8$
78. If  $\int_0^\infty \frac{x^2 dx}{(x^2 + a^2)(x^2 + b^2)(x^2 + c^2)} = \frac{\pi}{2(a+b)(b+c)(c+a)}$  then the value of  $\int_0^\infty \frac{dx}{(x^2 + 4)(x^2 + 9)}$  is
- (a)  $\frac{\pi}{60}$       (b)  $\frac{\pi}{40}$       (c)  $\frac{\pi}{40}$       (d)  $\frac{\pi}{80}$

79. If for the differential equation  $y' = \frac{y}{x} + \phi\left(\frac{x}{y}\right)$ , the general solution is  $y = \frac{x}{\log|cx|}$ , then  $\phi\left(\frac{x}{y}\right)$  is given by  
 (a)  $-\frac{x^2}{y^2}$  (b)  $\frac{y^2}{x^2}$  (c)  $\frac{x^2}{y^2}$  (d)  $-\frac{y^2}{x^2}$
80. The line joining origin and point of curves  $ax^2 + 2hxy + by^2 + 2gx = 0$  and  $a_1x^2 + 2h_1xy + b_1y^2 + 2g_1x = 0$  will be mutually perpendicular if  
 (a)  $g(a_1 + b_1) = g_1(a + b)$  (b)  $g(a + b) = g_1(a_1 + b_1)$   
 (c)  $a + b = gg_1(a_1 + b_1)$  (d)  $ag + a_1g_1 = bg + b_1g_1$
81. The locus of the middle points of the portion of the tangents of the ellipse  $\frac{x^2}{a^2} + \frac{y^2}{b^2} = 1$ , included between the axis is the curve  
 (a)  $\frac{x^2}{a^2} + \frac{y^2}{b^2} = 4$  (b)  $\frac{a^2}{x^2} + \frac{b^2}{y^2} = 4$  (c)  $a^2x^2 + b^2y^2 = 4$  (d)  $b^2x^2 + a^2y^2 = 4$
82. The angle of intersection of the normals at the point  $\left(\frac{-5}{\sqrt{2}}, \frac{3}{\sqrt{2}}\right)$  of the curves  $x^2 - y^2 = 8$  and  $9x^2 + 25y^2 = 225$  is  
 (a) 0 (b)  $\frac{\pi}{4}$  (c)  $\frac{\pi}{3}$  (d)  $\frac{\pi}{2}$
83. The area of the region lying inside  $x^2 + (y - 1)^2 = 1$  and outside  $c^2x^2 + y^2 = c^2$ , where  $c = (\sqrt{2} - 1)$  is  
 (a)  $(4 - \sqrt{2})\frac{\pi}{4} + \frac{1}{\sqrt{2}}$  (b)  $(4 + \sqrt{2})\frac{\pi}{4} - \frac{1}{\sqrt{2}}$   
 (c)  $(4 + \sqrt{2})\frac{\pi}{4} + \frac{1}{\sqrt{2}}$  (d) None of these
84. The equation of the parabola whose focus is the point (0, 0) and the tangent at the vertex is  $x - y + 1 = 0$ , is  
 (a)  $x^2 + y^2 - 2xy - 4x + 4y - 4 = 0$  (b)  $x^2 + y^2 - 2xy + 4x - 4y - 4 = 0$   
 (c)  $x^2 + y^2 + 2xy - 4x + 4y - 4 = 0$  (d)  $x^2 + y^2 + 2xy - 4x - 4y + 4 = 0$
85. If PQ is a double ordinate of the hyperbola  $\frac{x^2}{a^2} - \frac{y^2}{b^2} = 1$ , such that OPQ is an equilateral triangle, O being the centre of the hyperbola. Then the eccentricity e of the hyperbola satisfies  
 (a)  $1 < e < \frac{2}{\sqrt{3}}$  (b)  $e = \frac{2}{\sqrt{3}}$  (c)  $e = \frac{\sqrt{3}}{2}$  (d)  $e > \frac{2}{\sqrt{3}}$

86. If the vector  $\vec{a}$  and  $\vec{b}$  are perpendicular to each other, then a vector  $\vec{V}$  in terms of  $\vec{a}$  and  $\vec{b}$  satisfying the equations  $\vec{V} \cdot \vec{a} = 0$ ,  $\vec{V} \cdot \vec{b} = 1$  and  $[\vec{V} \vec{a} \vec{b}] = 1$ , is
- (a)  $\frac{\vec{b}}{|\vec{b}|^2} + \frac{(\vec{a} \times \vec{b})}{|\vec{a} \times \vec{b}|^2}$  (b)  $\frac{\vec{b}}{|\vec{b}|} + \frac{(\vec{a} \times \vec{b})}{|\vec{a} \times \vec{b}|^2}$
- (c)  $\frac{\vec{b}/|\vec{b}|^2}{(\vec{a} \times \vec{b})/|\vec{a} \times \vec{b}|}$  (d) None of these
87. Suppose values taken by a variable X are such that  $a \leq x_i \leq b$ , where  $x_i$  denotes the value of X in the  $i^{\text{th}}$  case for  $i = 1, 2, \dots, n$ , then
- (a)  $a \leq \text{Var}(X) \leq b$  (b)  $a^2 \leq \text{Var}(X) \leq b^2$
- (c)  $\frac{a^2}{4} \leq \text{Var}(X)$  (d)  $(b - a)^2 \geq \text{Var}(X)$
88. If  $\sin \theta = \frac{12}{13}$ ,  $\left(0 < \theta < \frac{\pi}{2}\right)$  and  $\cos \phi = -\frac{3}{5}$ ,  $\left(\pi < \phi < \frac{3\pi}{2}\right)$ , then  $\sin(\theta + \phi)$  will be
- (a)  $-\frac{56}{61}$  (b)  $-\frac{56}{65}$  (c)  $\frac{1}{65}$  (d)  $-\frac{56}{60}$
89. The general value of  $\theta$  obtained from the equation  $\cos 2\theta = \sin \alpha$ , is ( $n \in \mathbb{Z}$ )
- (a)  $2\theta = \frac{\pi}{2} - \alpha$  (b)  $\theta = 2n\pi \pm \left(\frac{\pi}{2} - \alpha\right)$
- (c)  $\theta = \frac{n\pi + (-1)^n \pi}{2}$  (d)  $\theta = n\pi \pm \left(\frac{\pi}{4} - \frac{\alpha}{2}\right)$
90. If two towers of heights  $h_1$  and  $h_2$  subtend angles  $60^\circ$  and  $30^\circ$  respectively at the mid-point of the line joining their feet, then  $h_1 : h_2 =$
- (a) 1 : 2 (b) 1 : 3 (c) 2 : 1 (d) 3 : 1